

# Liquid Crystal Projector **dv445/dv465**

Model No.218/No.219

**Liesegang**  
projection technology

ENGLISH

FRANÇAIS

DEUTSCH

ESPAÑOL

ITALIANO

TECHNICAL

## **User's Manual - Operating Guide**

Please read this user's manual thoroughly to ensure correct usage understanding.

## **Manuel d'utilisation - Guide d'utilisation**

Nous vous recommandons de lire attentivement ce manuel pour bien assimiler le fonctionnement de l'appareil.

## **Benutzerhandbuch**

Um zu gewährleisten, daß Sie die Bedienung des Geräts verstanden haben, lesen Sie dieses Handbuch bitte sorgfältig.

## **Manual de usuario - Guía de funcionamiento**

Lea atentamente el manual de usuario del proyector para garantizar un uso adecuado del mismo.

## **Manuale d'istruzioni - Guida operativa**

Vi preghiamo di leggere attentamente il manuale d'istruzioni per garantire una corretta comprensione delle istruzioni.

## **TECHNICAL**

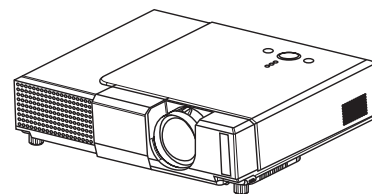

## Projector

# User's Manual – Operating Guide

ENGLISH

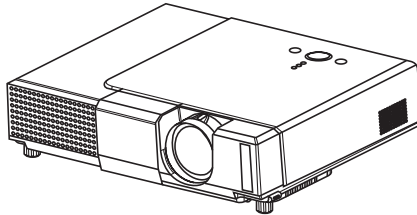

Thank you for purchasing this projector.

**⚠ WARNING** ▶ Before using, read the "User's Manual - Safety Guide" and these manuals to ensure correct usage through understanding. After reading, store them in a safe place for future reference.

### About this manual

Various symbols are used in this manual. The meanings of these symbols are described below.

- ⚠ WARNING** This symbol indicates information that, if ignored, could possibly result in personal injury or even death due to incorrect handling.
- ⚠ CAUTION** This symbol indicates information that, if ignored, could result possibly in personal injury or physical damage due to incorrect handling.

 Please refer to the pages written following this symbol.

**NOTE** • The information in this manual is subject to change without notice.

- The manufacture assumes no responsibility for any errors that may appear in this manual.
- The reproduction, transmission or use of this document or contents is not permitted without express written authority.

### Trademark acknowledgment

- VGA and XGA are registered trademarks of the International Business Machines Corporation.
  - Apple and Mac are registered trademarks of the Apple Computer, Inc.
  - VESA and SVGA are trademarks of the Video Electronics Standard Association.
  - Windows is a registered trademark of the Microsoft Corporation.
  - Internet Explorer is a trademark of the Microsoft Corporation.
- All other trademarks are the property of their respective owners.

Contents

<b>About this manual</b> . . . . .	<b>1</b>		<b>PICTURE Menu</b> . . . . .	<b>25</b>	
<b>Contents</b> . . . . .	<b>2</b>		Bright, Contrast, Gamma, Color temp, Color, Tint, Sharpness, Progressive, My memory		
<b>Projector features</b> . . . . .	<b>3</b>		<b>IMAGE Menu</b> . . . . .	<b>28</b>	
<b>Preparations</b> . . . . .	<b>3</b>		Aspect, Over scan, V. position, H. position, H. phase, H. size, Auto adjust		
<b>Part names</b> . . . . .	<b>4</b>		<b>INPUT Menu</b> . . . . .	<b>30</b>	
Projector . . . . .	4		Color space, Component, Video format, Frame lock, Information		
Controls . . . . .	5		<b>SETUP Menu</b> . . . . .	<b>32</b>	
Remote control . . . . .	5		Keystone, Whisper, Mirror, Volume		
<b>Setting up</b> . . . . .	<b>6</b>		<b>SCREEN Menu</b> . . . . .	<b>33</b>	
Arrangement . . . . .	7		Language, Menu position, OSD bright, Blank, Start up, MyScreen, MyScreen lock, Message		
Adjusting the projector's elevator . . .	8		<b>OPTION Menu</b> . . . . .	<b>36</b>	
About the filter cover for bottom-up use . .	9		Search, Auto off, Lamp time, Filter time, Service		
Connecting your devices . . . . .	10		<b>Maintenance</b> . . . . .	<b>38</b>	
Connecting power supply . . . . .	13		Lamp . . . . .	38	
<b>Remote control</b> . . . . .	<b>14</b>		Air filter . . . . .	40	
Putting batteries . . . . .	14		Other care . . . . .	41	
Using the remote control . . . . .	15		<b>Troubleshooting</b> . . . . .	<b>42</b>	
<b>Power on/off</b> . . . . .	<b>16</b>		Related messages . . . . .	42	
Turning on the power . . . . .	16		Regarding the indicator lamps . . . .	44	
Turning off the power . . . . .	16		Phenomena that may easily be mistaken for machine defects . . . .	46	
<b>Operating</b> . . . . .	<b>17</b>		<b>Warranty and after-service</b> . . .	<b>48</b>	
Adjusting the volume . . . . .	17		<b>Specifications</b> . . . . .	<b>48</b>	
Temporarily muting the sound . . . .	17				
Selecting an input signal . . . . .	17				
Searching an input signal . . . . .	18				
Selecting the aspect ratio . . . . .	18				
Adjusting the zoom and focus . . . .	18				
Using the automatic adjustment feature .	19				
Adjusting the position . . . . .	19				
Correcting the keystone distortions	19				
Using the magnify feature . . . . .	20				
Freezing the screen . . . . .	20				
Temporarily blanking the screen . .	20				
Operating the computer screen . . .	21				
<b>Multifunctional settings</b> . . . .	<b>22</b>				
Using the menu function . . . . .	22				
<b>EASY Menu</b> . . . . .	<b>23</b>				
Aspect, Keystone, Mode, Bright, Contrast, Color, Tint, Sharpness, Whisper, Mirror, Reset, Filter time, Language, Go to advanced menu					

## Projector features

This projector is used to project various computer signals as well as NTSC / PAL / SECAM video signals onto a screen. It requires just a little space for installation and gets a large image from short distance.

- High Brightness  
Newly developed 165W UHB (Ultra High Brightness) lamp gives you a higher brightness image on a screen. The image can be still kept as bright and clean enough for use in bright rooms.
- Low Noise  
WHISPER mode is equipped for reducing acoustic noise to realize quieter operation. It is perfect for use in low luminance rooms where low noise is more important than brightness.
- Rich Connectivity  
This projector has a variety of I/O ports. It can be easily connected to many signal sources like PC, DVD and so on. The rich connectivity provides you more options to make your presentation impressive.
- Compact Body  
Even with its many features, this projector is extremely compact and slim, which gives you more flexibility and usability to use it where you want.

## Preparations

### About contents of package

Please see the "Contents of package" of the "User's manual - Quick guide". Your projector should come with the items shown there. Contact immediately your dealer if anything is missing.

**NOTE** • Keep the original packing materials for future reshipment. For moving the projector, be sure to use the original packing material. Use special caution for the lens part.

Part names

Part names

**Projector**

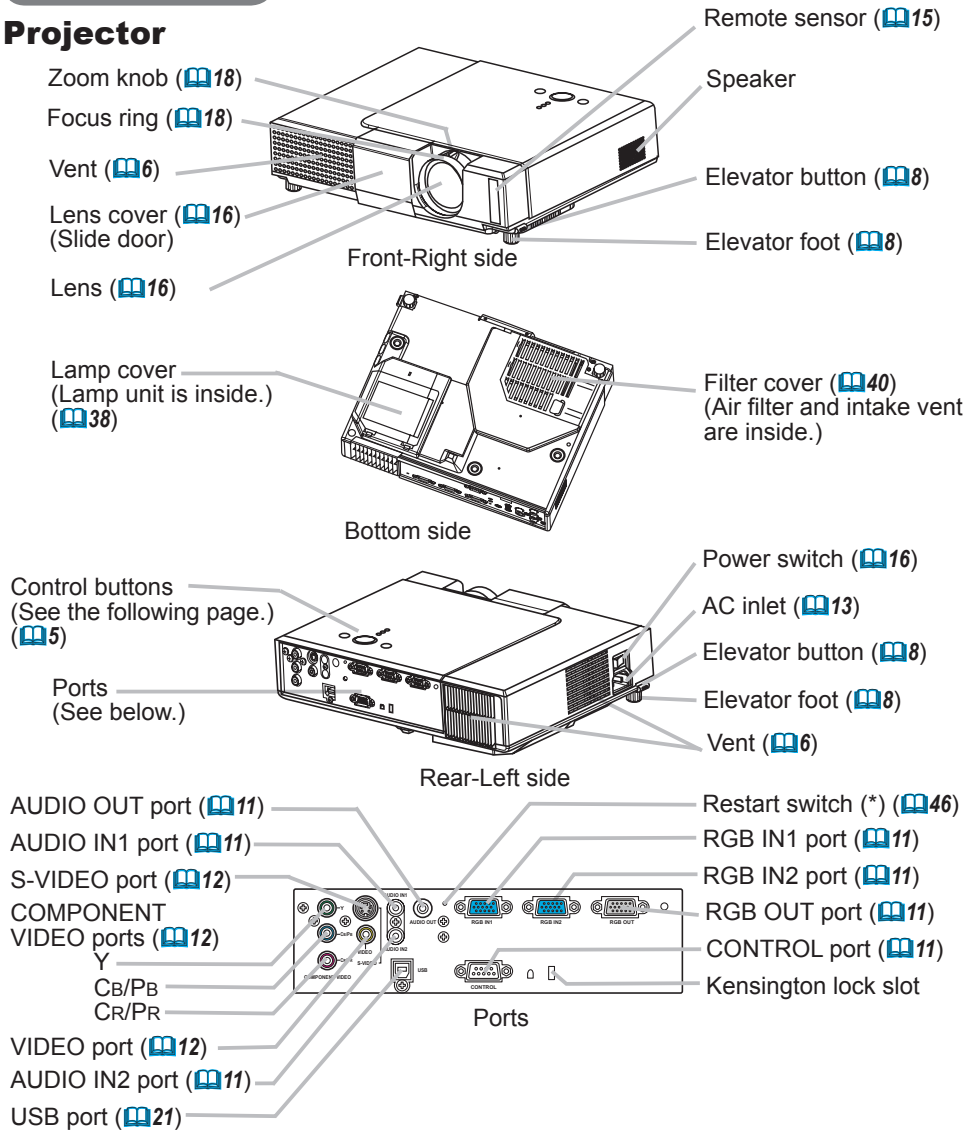

**NOTE (\*) About Restart switch:** This Projector is controlled by an internal microprocessor. Under certain exceptional circumstances, the projector may not operate correctly and the microprocessor will need to be reset. In such a case, please push the Restart switch by using a cocktail stick or similar and before turning on again, make the projector cool down at least 10 minutes without operating. Only push the Restart switch in these exceptional instances.

## Control buttons

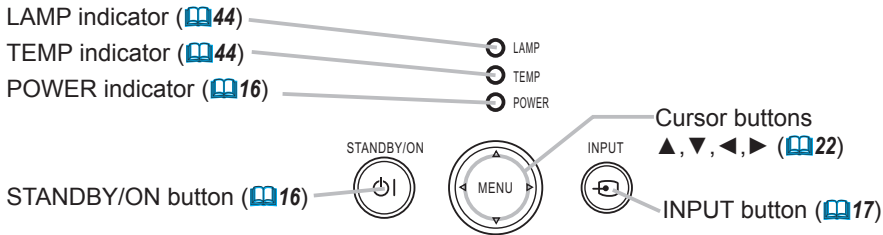

## Remote control

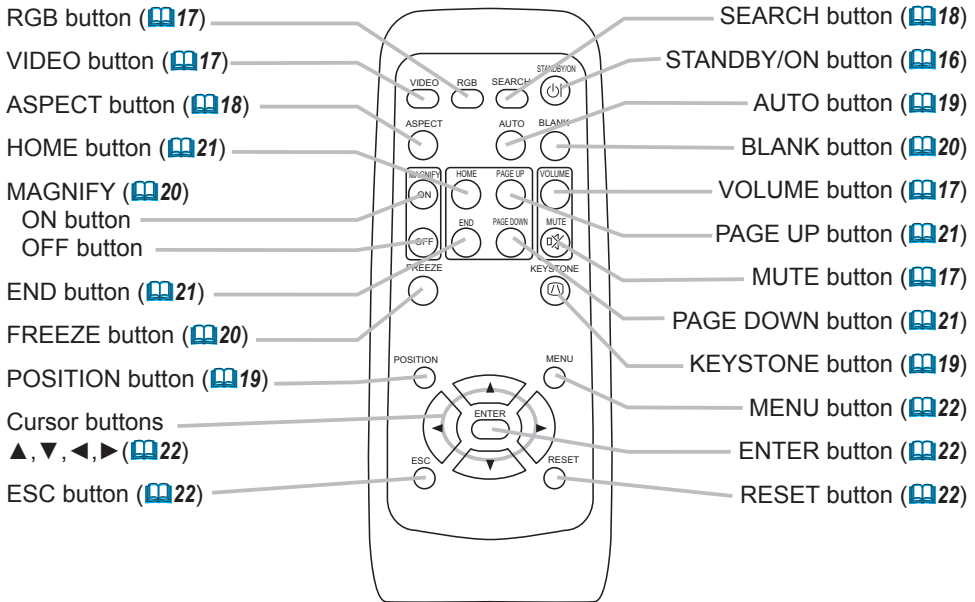

## Setting up

- ⚠ WARNING** ► Place the projector in a stable position horizontally. A fall or a turnover could cause an injury and/or damage to the projector. Then using damaged projector could result in a fire and/or an electric shock.
- Don't place the projector on an unstable, slant or vibrant surface such as a wobbly or inclined stand.
  - Do not place the projector in the side/front/rear-up position, except care of the air filter.
  - For the projector installed bottom-up, use the accessory filter cover for bottom-up use. And in the case of a ceiling installation or the like, contact your dealer before installation.
- Place the projection in a cool place, and pay attention enough to ventilation. The high temperature of the projector could cause a fire, a burn and/or malfunction to the projector.
- Don't stop up, block and cover the projector's vents.
  - Keep a space of 30 cm or more between the sides and other objects such as walls.
  - Don't place the projector on a metallic thing or anything weak in heat.
  - Don't place the projector on a carpet, cushion or bedding.
  - Don't place the projector in direct sunlight or near a hot object such as heater.
  - Put nothing about lens and vents of the projector. Put nothing on the projector.
  - Put nothing that is sucked or sticks to the bottom of projector. This projector has some intake vents also on the bottom.
- Do not place the projector on the place that gets wet. Damping the projector or inserting liquid in the projector could cause a fire, an electric shock and/or malfunction to the projector.
- Don't place the projector in a bathroom or the outdoors.
  - Put nothing containing the liquid near the projector.
- ⚠ CAUTION** ► Avoid a smoky, humid or dusty place. Placing the projector in such place could cause a fire, an electric shock and/or malfunction to the projector.
- Don't place the projector near a humidifier, a smoking space or a kitchen.
  - Put nothing containing the liquid near the projector.
- Adjust the direction of the projector to keep light from directly hitting the projector's remote sensor.

## Arrangement

Refer to the illustrations and tables below to determine the screen size and projection distance.

The values shown in the table are calculated for a full size screen: 1024 x 768

- (a) The screen size (diagonal)
- (b) Distance from the projector to the screen ( $\pm 10\%$ )
- (c) The height of the screen ( $\pm 10\%$ )

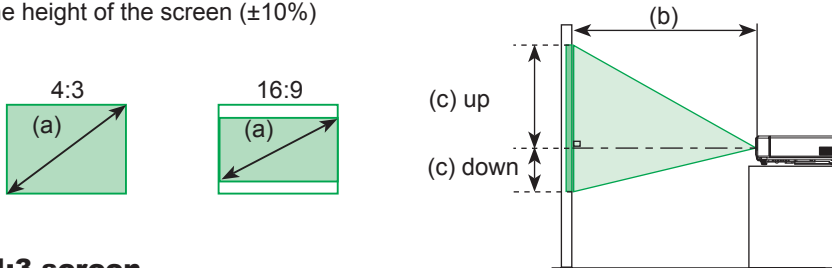

### At 4:3 screen

(a) Screen size [inch (m)]	(b) Projection distance [m (inch)]		(c) Screen height [cm (inch)]	
	min.	max.	down	up
30 (0.8)	0.9 (35)	1.1 (42)	5 (2)	41 (16)
40 (1.0)	1.2 (47)	1.4 (56)	6 (2)	55 (22)
50 (1.3)	1.5 (59)	1.8 (71)	8 (3)	69 (27)
60 (1.5)	1.8 (72)	2.2 (85)	9 (4)	82 (32)
70 (1.8)	2.1 (84)	2.5 (100)	11 (4)	96 (38)
80 (2.0)	2.4 (96)	2.9 (114)	12 (5)	110 (43)
90 (2.3)	2.7 (108)	3.3 (129)	14 (5)	123 (49)
100 (2.5)	3.1 (120)	3.6 (143)	15 (6)	137 (54)
120 (3.0)	3.7 (144)	4.4 (172)	18 (7)	165 (65)
150 (3.8)	4.6 (181)	5.5 (216)	23 (9)	206 (81)
200 (5.1)	6.1 (242)	7.3 (288)	30 (12)	274 (108)
250 (6.4)	7.6 (303)	9.2 (361)	38 (15)	343 (135)
300 (7.6)	9.2 (363)	11.0 (433)	46 (18)	411 (162)

### At 16:9 screen

(a) Screen size [inch (m)]	(b) Projection distance [m (inch)]		(c) Screen height [cm (inch)]	
	min.	max.	down	up
30 (0.8)	1.0 (38)	1.2 (46)	-1 (0)	39 (15)
40 (1.0)	1.3 (52)	1.6 (62)	-2 (-1)	51 (20)
50 (1.3)	1.6 (65)	2.0 (77)	-2 (-1)	64 (25)
60 (1.5)	2.0 (78)	2.4 (93)	-2 (-1)	77 (30)
70 (1.8)	2.3 (91)	2.8 (109)	-3 (-1)	90 (35)
80 (2.0)	2.7 (105)	3.2 (125)	-3 (-1)	103 (41)
90 (2.3)	3.0 (118)	3.6 (140)	-4 (-1)	116 (46)
100 (2.5)	3.3 (131)	4.0 (156)	-4 (-2)	129 (51)
120 (3.0)	4.0 (158)	4.8 (188)	-5 (-2)	154 (61)
150 (3.8)	5.0 (197)	6.0 (235)	-6 (-2)	193 (76)
200 (5.1)	6.7 (264)	8.0 (314)	-8 (-3)	257 (101)
250 (6.4)	8.4 (330)	10.0 (393)	-10 (-4)	322 (127)
300 (7.6)	10.1 (396)	12.0 (472)	-12 (-5)	386 (152)



## Adjusting the projector's elevator

**⚠ WARNING** ► Do not adjust the projector's elevator during use or immediately after use. Handling while the projector is in a high temperature could cause a burn and/or malfunction to the projector.

**⚠ CAUTION** ► If you press the elevator button without holding the projector, the projector might crash down, overturn, smash your fingers and possibly result in malfunction. To prevent damaging the projector and injuring yourself, always hold the projector whenever using the elevator buttons to adjust the elevator feet.

► Except for inclining by the elevator feet adjustment, place the projector horizontally.

You can use the elevator feet to make adjustments if the surface on which you need to set the projector is uneven or if you otherwise need to adjust the angle of projection. The adjustment range of the elevator feet is 0 to 9 degrees.

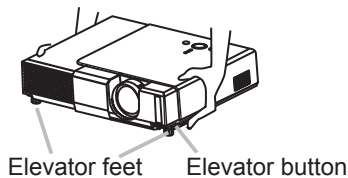

1. After making sure that the projector is cool adequately, press and hold in the elevator buttons while holding the projector.  
The elevator buttons and the elevator feet are on the both sides.
2. Raise or lower the projector to the desired height and the release the elevator buttons.  
When you release the elevator buttons, the elevator feet will lock into position.
3. As necessary, you can also finely adjust the height of the projector by twisting the elevator feet by hand.

## About the filter cover for bottom-up use

**⚠ WARNING** ▶ Do not replace the filter cover during use or immediately after use. While the projector connects with a power supply, or the projector is in a high temperature state, handling could cause an electric shock, a fire, a burn and/or malfunction to the projector. Before handling, make sure the power switch is off and the power cord is not plugged in, then wait at least 45 minutes.

When the projector is installed bottom up, please use the accessory filter cover for bottom-up use. It is higher than usual filter cover, to keep the space for intake ventilation. Please change in the following procedure.

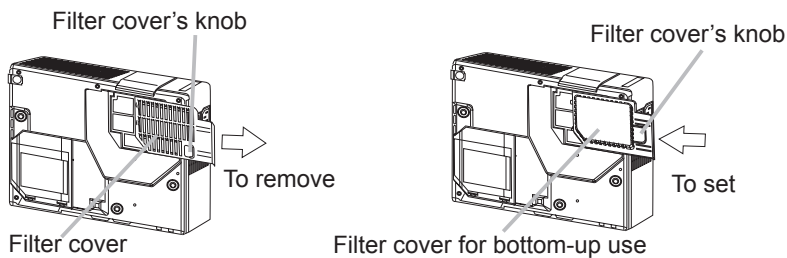

1. After making sure that the projector is cool adequately, slowly turn the projector so that the lens-side is facing up. Please be careful for a projector not to fall. While the projector is placed lens-side up, hold the projector.
2. Putting a finger on the filter cover's knob, slide the filter cover in the direction of the arrow to remove it.
3. Replace the filter cover for bottom-up use and snap it back into place.
4. Slowly turn the projector so that the top is facing up.

## Connecting your devices

**⚠ CAUTION** ▶ Turn off all devices prior to connecting them to the projector. Attempting to connect a live device to the projector may generate extremely loud noises or other abnormalities that may result in malfunction and/or damage to the device and/or projector.

▶ Use the accessory cable or a designated-type cable for the connection. Some cables have to be used with core set. A too long cable may cause a certain picture degradation. Please consult with your dealer for details. For cables that have a core only at one end, connect the core to the projector.

▶ Make sure that you connect devices to the correct port. Incorrect connection may result in malfunction and/or damage to the device and/or projector.

**NOTE** • Whenever attempting to connect a laptop computer to the projector, be sure to activate the laptop's RGB external image output (set the laptop to CRT display or to simultaneous LCD and CRT display). For details on how this is done, please refer to the instruction manual of the corresponding laptop computer.

- Secure the screws on the connectors and tighten.
- Some computers may have multiple display screen modes. Use of some of these modes will not be possible with this projector.
- For some RGB signal modes, the optional Mac adapter is necessary.
- When the image resolution is changed on a computer, depending on an input, automatic adjust function may take some time and may not be completed. In this case, you may not be able to see a check box to select "Yes/No" for the new resolution on Windows. Then the resolution will go back to the original. It might be recommended to use other CRT or LCD monitors to change the resolution.

### **About Plug-and-Play capability**

Plug-and-Play is a system composed of the computer, its operating system and peripheral equipment (i.e. display devices). This projector is compatible with VESA DDC 2B. Plug-and-Play can be achieved by connecting this projector to computers that are VESA DDC (display data channel) compatible.

- Please take advantage of this function by connecting the accessory RGB cable to the RGB IN1 port (DDC 2B compatible). Plug-and-Play may not work properly if any other type of connection is attempted.
- Please use the standard drivers in your computer as this projector is a Plug-and-Play monitor.

Examples of connection with a computer

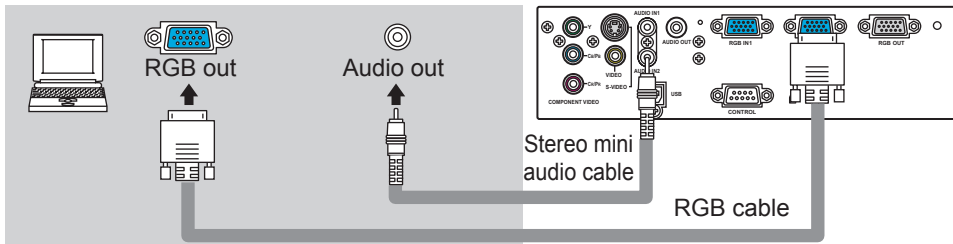
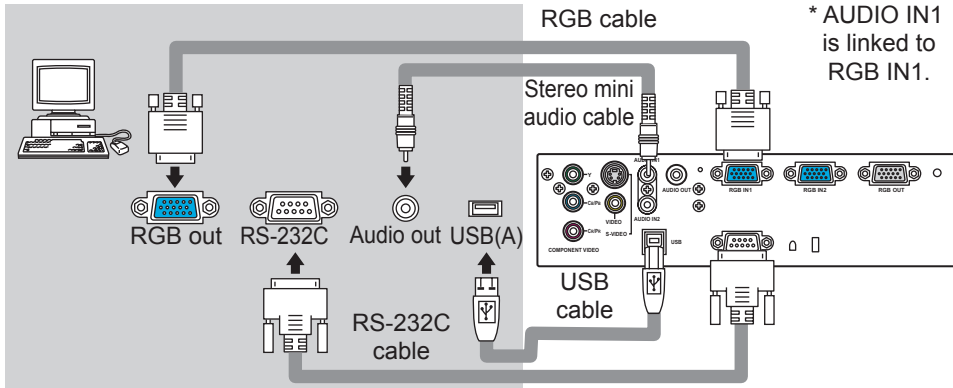

Connecting to a monitor (output)



Connecting to a speaker with amplifier (output)

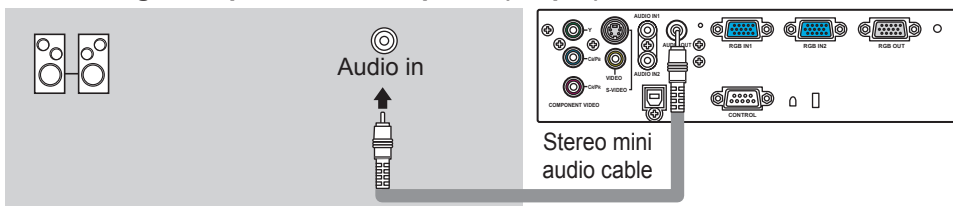

### Examples of connection with a VCR/DVD player

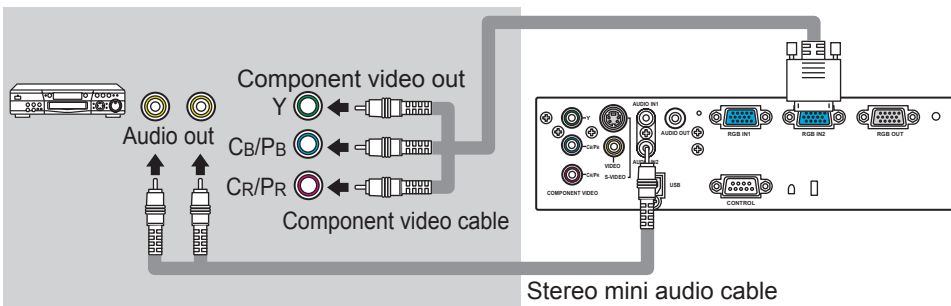
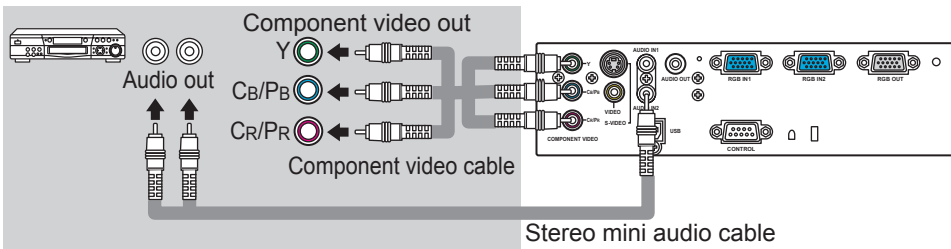
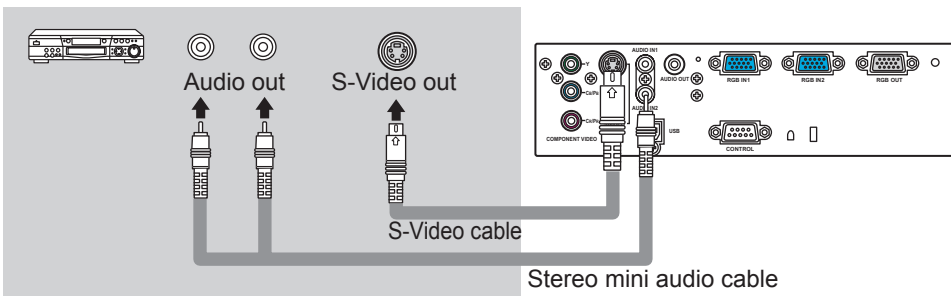
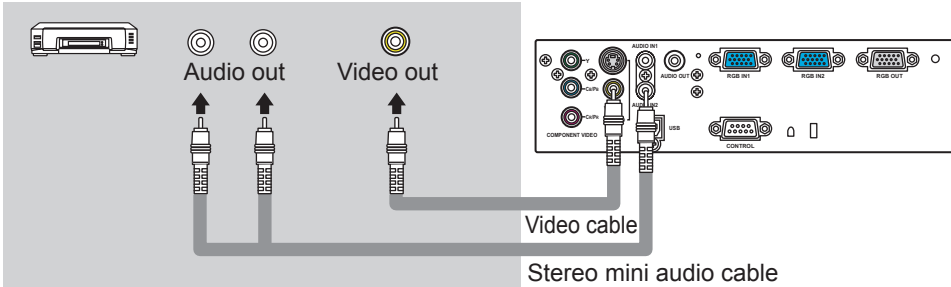

## Connecting power supply

- ⚠ WARNING** ► Please use extra caution when connecting the power cord as incorrect or faulty connections may result in fire and/or electrical shock.
- Only use the power cord that came with the projector. If it is damaged, contact your dealer to newly get correct one.
  - Only plug the power cord into an outlet rated for use with the power cord's specified voltage range.
  - Never modify the power cord. Never attempt to defeat the ground connection of the three-pronged plug.

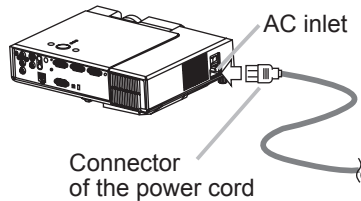

1. Connect the connector of the power cord to the AC inlet of the projector.
2. Firmly plug the power cord's plug into the outlet.

## Remote control

### Putting batteries

**⚠ WARNING** ► Always handle the batteries with care and use them only as directed. Improper use may result in battery explosion, cracking or leakage, which could result in fire, injury and/or pollution of the surrounding environment.

- Be sure to use only the batteries specified. Do not use batteries of different types at the same time. Do not mix a new battery with used one.
- Make sure the plus and minus terminals are correctly aligned when loading a battery.
- Keep a battery away from children and pets.
- Do not recharge, short circuit, solder or disassemble a battery.
- Do not allow a battery in a fire or water. Keep batteries in a dark, cool and dry place.
- If you observe a leakage of a battery, wipe out the flower and then replace a battery. If the flower adheres your body or clothes, rinse well with water immediately.

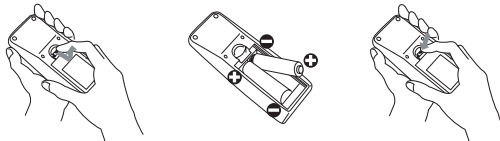

1. Remove the battery cover.  
Slide back and remove the battery cover in the direction of the arrow.
2. Insert the batteries.  
Align and insert the two AA batteries according to their plus and minus terminals as indicated in the remote control.
3. Close the battery cover.  
Replace the battery cover in the direction of the arrow and snap it back into place.

## Using the remote control

**⚠ CAUTION** ▶ Be careful in handling the remote control.

- Do not drop or otherwise expose the remote control to physical impact.
- Do not get the remote control wet or place it on wet objects. Doing so may result in malfunction.
- Remove the batteries from the remote control and store them in a safe place if you won't be using the remote control for an extended period.
- Replace the batteries whenever the remote control starts to malfunction.
- When strong lights, such as direct sunlight or light from an extremely close range (such as from an inverter fluorescent lamp), hit the projector's remote sensor, the remote control may cause to function. Adjust the direction of the projector to keep light from directly hitting the projector's remote sensor.

The remote control works with the projector's remote sensor.

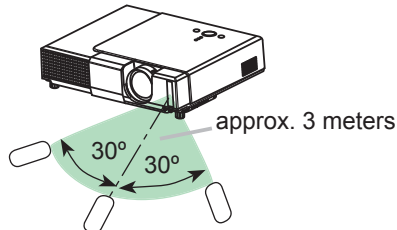

- The range of the remote sensor is 3 meters with a 60-degree range (30 degrees to the left and right of the remote sensor).
- Also a remote signal reflected in the screen etc. may be available. If it is difficult to send a remote signal to the sensor directly, please try.
- Since the remote control uses infrared light to send signals to the projector (Class1 LED), be sure to use the remote control in an area free from obstacles that could block the remote control's output signal to the projector.



## Power on/off

### Power on/off

**⚠ WARNING** ► When the power is on, a strong light is emitted. Do not look into the lens or vents of the projector.

**NOTE** • Turn the power on/off in right order. Please power on the projector before the connected devices. Power off the projector after the connected devices.

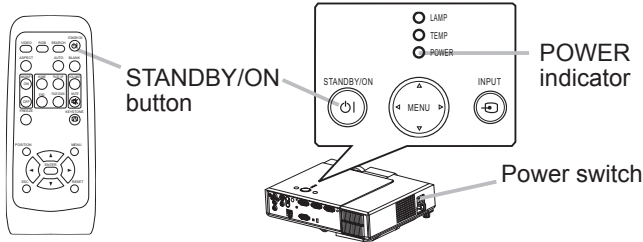

### Turning on the power

1. Make sure that the power cord is firmly and correctly connected to the projector and outlet.
2. Open the lens cover, and set the power switch to the ON position.

The power indicator will light to solid orange. Then wait several seconds because buttons may not function for these several seconds.

3. Press the STANDBY/ON button on the projector or remote control.  
The projector lamp will light up and the POWER indicator will begin blinking green. When the power is completely on, the indicator will stop blinking light green.

To display the picture, select an input signal according to the section "Selecting an input signal" (17).

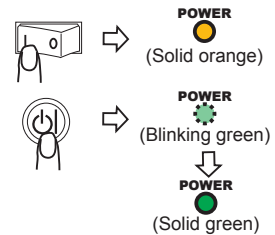

### Turning off the power

1. Press the STANDBY/ON button on the projector or remote control.  
The message "Power off?" will appear on the screen for approximately 5 seconds.
2. Press the STANDBY/ON button on the projector or remote control again while the message is visible.  
The projector lamp will go off, and the POWER indicator will begin blinking orange.

Then the POWER indicator will stop blinking and light to solid orange when the lamp cooling is complete.

3. Make sure that the power indicator lights to solid orange, set the power switch to the OFF position. The POWER indicator will go off. Close the lens cover.

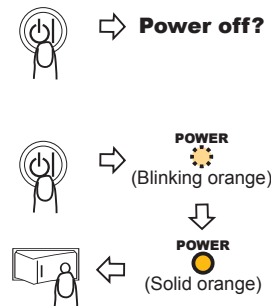

## Operating

**Adjusting the volume**

1. Press the VOLUME button on the remote control.
  - A dialog will appear on the screen to aid you in adjusting the volume.
2. Use the cursor buttons ▲/▼ to adjust the volume.
  - To close the dialog and complete the operation, press the VOLUME button again. Even if you don't do anything, the dialog will automatically disappear after a few seconds.

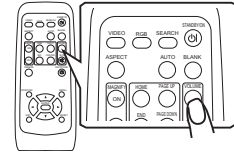

ENGLISH

**Temporarily muting the sound**

1. Press the MUTE button on the remote control.
  - A dialog will appear on the screen indicating that you have muted the sound.
  - To restore the sound, press the MUTE or VOLUME button. Even if you don't do anything, the dialog will automatically disappear after a few seconds.

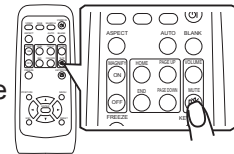
**Selecting an input signal**

1. Press the INPUT button on the projector.
  - Each time you press the button, the projector switches its input port as below.

RGB IN1 → RGB IN2 → COMPONENT VIDEO → S-VIDEO → VIDEO

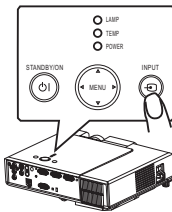

1. Press the RGB button on the remote control to select an input port for RGB signal.
  - Each time you press the button, the projector switches its RGB input port as below.

RGB IN1 ↔ RGB IN2

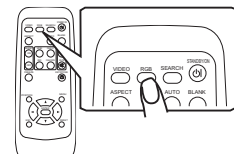

- When the TURN ON is selected to the item SEARCH of OPTION menu (36), the projector selects the RGB IN1 port at first. If no input is detected at the RGB IN1 port, projector will check the RGB IN2 port.

1. Press the VIDEO button on the remote control to select an input port for video signal.
  - Each time you press the button, the projector switches its video input port as below.

COMPONENT VIDEO → S-VIDEO → VIDEO

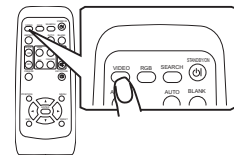

- When the TURN ON is selected to the item SEARCH of OPTION menu (36), the projector selects the COMPONENT VIDEO port at first. If no input is detected at the COMPONENT VIDEO port, projector will begin to check other ports.

## Searching an input signal

1. Press the SEARCH button on the remote control.
  - The projector will begin to check its input ports in order to find any input signals.

Then when an input is found, the projector will stop searching and display the image. If no signal is found, the projector will return to the state selected before the operation.

RGB IN1 → RGB IN2 → COMPONENT VIDEO → S-VIDEO → VIDEO

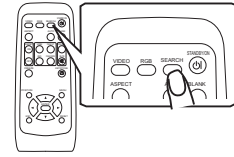

## Selecting an aspect ratio

1. Press the ASPECT button on the remote control.
  - Each time you press the button, the projector switches the mode for aspect ratio in turn.

○ At a RGB signal  
NORMAL → 4:3 → 16:9



○ At a video signal /no signal  
4:3 → 16:9 → SMALL



- The NORMAL mode keeps the original aspect ratio of the signal.
- At a HDTV signal of 1125i (1080i) or 750p (720p) of COMPONENT VIDEO input, only 16:9 mode can be selected.
- Performing the automatic adjustment initializes the aspect ratio setting.

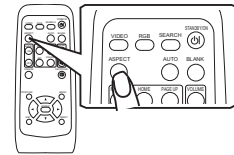

## Adjusting the zoom and focus

1. Use the zoom knob to adjust the screen size.
2. Use the focus ring to focus the picture.

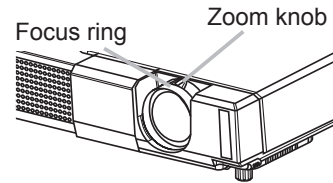

## Using the automatic adjustment feature

1. Press the AUTO button on the remote control.

### ○ At a RGB signal

The vertical position, the horizontal position, the clock phase and horizontal size will be automatically adjusted.

Make sure that the application window is set to its maximum size prior to attempting to use this feature. A dark picture may still be incorrectly adjusted. Use a bright picture when adjusting.

### ○ At a video signal

The video format best suited for the respective input signal will be selected automatically.

This function is available only when the AUTO mode is selected to the item VIDEO FORMAT of the INPUT menu (30). For a component video signal, the signal type is identified automatically independently of this function.

- The automatic adjustment operation requires approximately 10 seconds. Also please note that it may not function correctly with some input.

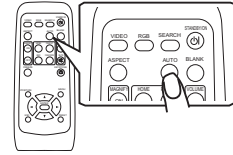

ENGLISH

## Adjusting the position

1. Press the POSITION button on the remote control.  
The "POSITION" indication will appear on the screen.
2. Use the cursor buttons ▲/▼/◀/▶ to adjust the picture position.

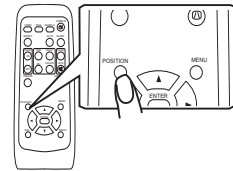

When you want to reset the operation, press the RESET button on the remote control during the operation.

To complete this operation, press the POSITION button again. Even if you don't do anything, the dialog will automatically disappear after a few seconds.

- When this function is performed at a video signal, a certain extra such as a line may appear outside a picture.

## Correcting the keystone distortions

1. Press the KEYSTONE button on the remote control.  
A dialog will appear on the screen to aid you in correcting the distortion.

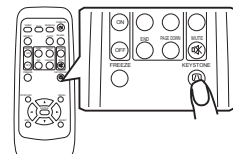

2. Use the cursor buttons ▲/▼ to correct the distortion.

To close the dialog and complete this operation, press the KEYSTONE button again. Even if you don't do anything, the dialog will automatically disappear after a few seconds.

- This function may not be work well with some input.
- The adjustable range for correcting will vary among inputs.

## Using the magnify feature

1. Press the ON button of MAGNIFY on the remote control.
  - The “MAGNIFY” indication will appear on the screen (although the indication will disappear after several seconds with no operation.), and the projector will enter the MAGNIFY mode.

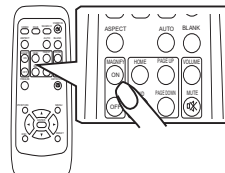

2. Use the cursor buttons ▲/▼ to adjust the zoom level.
  - To move the zoom area, press the POSITION button in the MAGNIFY mode, then use the cursor buttons ▲/▼/◀/▶ to move the area. And to finalize the zoom area, press the POSITION button again.

To exit the MAGNIFY mode and restore the screen to normal, press the OFF button of MAGNIFY on the remote control.

- The projector automatically exits the MAGNIFY mode when the input signal changes, or when an operation of changing the display condition (automatic adjustment, etc.) is executed.
- Although in the MAGNIFY mode, the keystone distortion condition may vary, it will be restored when the projector exit the MAGNIFY mode.

## Freezing the screen

1. Press the FREEZE button on the remote control.
  - The “FREEZE” indication will appear on the screen, and the projector will enter the FREEZE mode.

To exit the FREEZE mode and restore the screen to normal, press the FREEZE button again.

- The projector automatically exits the FREEZE mode when the input signal changes, or when one of the projector’s buttons or the remote control buttons of STANDBY/ON, SEARCH, RGB, VIDEO, BLANK, AUTO, ASPECT, VOLUME, MUTE, KEYSTONE, POSITION and MENU is pressed.
- If the projector continues projecting a still image for long time, the LCD panel might possibly be printed. Do not leave the projector in FREEZE mode for too long.

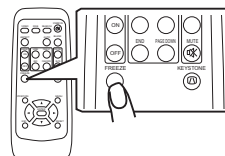

## Temporarily blanking the screen

1. Press the BLANK button on the remote control.
  - The blank screen will be displayed instead of the screen of input signal. Please refer to the item BLANK of section SCREEN menu (33).

To remove the blank screen and return to the input signal screen, press the BLANK button again.

- The projector automatically returns to the input signal screen when the input signal changes, or when one of the projector’s buttons or the remote control buttons are pressed.

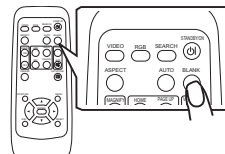

## Operating the computer screen

**⚠ CAUTION** ▶ Mistaken use of the mouse/keyboard control could damage your equipment.

- While using this function, please connect only with a computer.
- Before connecting, read the manuals of the computer you will connect.

ENGLISH

**NOTE** • It may not be possible to control notebook PC, and other computers with built-in pointing device (e.g. track ball), using this remote control. In this case, before connecting go into BIOS (system setup) and select external mouse, and disable the pointing device. In addition, the mouse may not function if the computer does not have the needed utility program. See your computer's hardware manual for details.

- The USB control can be used with Windows 95 OSR 2.1 or higher. It may not be possible to use the remote control, depending on the computer's configurations and mouse drivers.
- The USB control can be used only for the functions listed below. You cannot do things like press two buttons at once (for instance, pressing two buttons at the same time to move the mouse pointer diagonally).
- This function is not available while the lamp is warming up (the POWER indicator flashes green), and while adjusting the volume and display, correcting for trapezoidal distortion, zooming in on the screen, using the BLANK function, or displaying the menu screen.

### USB mouse and keyboard control

1. Connect the projector's USB port to the computer via the mouse cable.

Available function	Remote control operation
Move pointer	Use ▲, ▼, ◀, ▶ buttons
Left click with mouse	Press ENTER button
Right click with mouse	Press RESET button
Press keyboard's HOME key	Press HOME button
Press keyboard's END key	Press END button
Press keyboard's PAGE UP key	Press PAGE UP button
Press keyboard's PAGE DOWN key	Press PAGE DOWN button
Press keyboard's ESC key	Press ESC button

## Multifunctional settings

### Using the menu function

This projector has the following menus: PICTURE, IMAGE, INPUT, SETUP, SCREEN, OPTION and EASY MENU. Each of these menus is operated using the same methods. The basic operations of these menus are as follows.

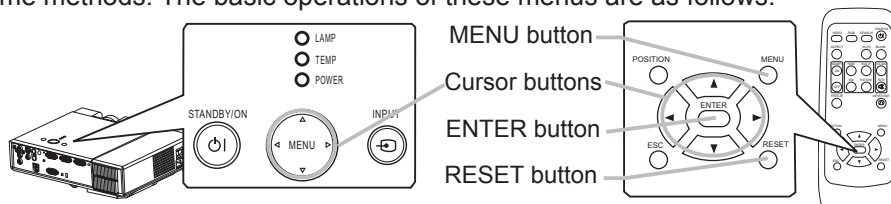

1. Press the MENU button on the remote control or one of the cursor buttons on the projector. The advanced MENU or EASY MENU will appear.

2. Use the cursor buttons ▲/▼ to select a menu.

- At the EASY MENU

If you want to change it to the advanced MENU, select the "Go to Advanced Menu".

- At the advanced MENU

Select a menu of PICTURE, IMAGE, INPUT, SETUP, SCREEN or OPTION.

If you want to change it to the EASY MENU, select the EASY MENU.

3. Then press the cursor button ► on the projector or remote control, or the ENTER button on the remote control to progress.

The display of the selected menu will be active.

4. Use the cursor buttons ▲/▼ to select an item to operate.

Then press the cursor button ► on the projector or remote control, or the ENTER button on the remote control to progress.

The operation menu of the selected item will appear.

5. Use the cursor buttons ▲/▼ to operate the item.

When you want to reset the operation, press the RESET button on the remote control during the operation. Note that items whose functions are performed simultaneously with operation (ex. LANGUAGE, H PHASE etc.) aren't reset.

When you want to return to the previous display, press the cursor button ◀ on the projector or remote control, or the ESC button on the remote control.

6. Press the MENU button on the remote control again to close the menu and complete this operation.

Even if you don't do anything, the dialog will automatically disappear after about 10 seconds.

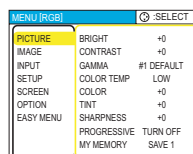

Advanced MENU

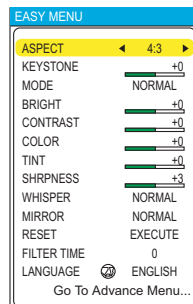

EASY MENU

EASY Menu

With the EASY MENU, items shown in the table below can be performed.

Select an item using the cursor buttons ▲/▼ on the projector or remote control. Then perform it referring to the following table.

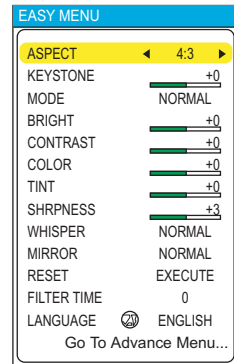

ENGLISH

Item	Description
<b>ASPECT</b>	Using the buttons ◀/▶ switches the mode for aspect ratio. See the item ASPECT of section IMAGE menu ( 28 ).
<b>KEYSTONE</b>	Using the buttons ◀/▶ corrects the keystone distortion. See the item KEYSTONE of section SETUP menu ( 32 ).
<b>MODE</b>	Using the buttons ◀/▶ switches the mode of picture type. The modes of picture type are combinations of a mode of GAMMA and a mode of COLOR TEMP. Choose a suitable mode according to the projected source. NORMAL ↔ CINEMA ↔ DYNAMIC ↑—————↑ NORMAL: (COLOR TEMP = MIDDLE) + (GAMMA = #1 DEFAULT) CINEMA: (COLOR TEMP = LOW) + (GAMMA = #2 DEFAULT) DYNAMIC: (COLOR TEMP = HIGH) + (GAMMA = #3 DEFAULT) • When the combination of GAMMA and COLOR TEMP differs from pre-assigned modes above, the display on the menu for the MODE is "CUSTOM". Please refer to the items GAMMA ( 25 ) and COLOR TEMP ( 26 ) of PICTURE menu.
<b>BRIGHT</b>	Using the buttons ◀/▶ adjusts the brightness. See the item BRIGHT of section PICTURE menu ( 25 ).
<b>CONTRAST</b>	Using the buttons ◀/▶ adjusts the contrast. See the item CONTRAST of section PICTURE menu ( 25 ).
<b>COLOR</b>	Using the buttons ◀/▶ adjusts the strength of whole color. See the item COLOR of section PICTURE menu ( 26 ).
<b>TINT</b>	Using the buttons ◀/▶ adjusts the tint. See the item TINT of section PICTURE menu ( 26 ).



**EASY Menu (continued)**

Item	Description
<b>SHARPNESS</b>	Using the buttons ◀/▶ adjusts the sharpness. See the item SHARPNESS of section PICTURE menu (📖26).
<b>WHISPER</b>	Using the buttons ◀/▶ turns off/on the whisper mode. See the item WHISPER of section SETUP menu (📖32).
<b>MIRROR</b>	Using the buttons ◀/▶ switches the mode for mirror status. See the item MIRROR of section SETUP menu (📖32).
<b>RESET</b>	Performing this item resets all of the items of EASY MENU except FILTER TIME and LANGUAGE. A dialog is displayed to make sure. Selecting RESET using the button ▲ performs reset.
<b>FILTER TIME</b>	Performing this item resets the filter timer which counts use time of air filter. A dialog is displayed to make sure. Selecting RESET using the button ▲ performs reset. See the item FILTER TIME of section OPTION menu (📖37).
<b>LANGUAGE</b>	Select the LANGUAGE to toggle the menu language. Refer to description of LANGUAGE in the SCREEN menu (📖33).
<b>Go To Advanced Menu</b>	Select the “Go To Advanced Menu” to use the menu of PICTURE, IMAGE, INPUT, SETUP, SCREEN or OPTION.

PICTURE Menu

With the PICTURE menu, items shown in the table below can be performed.

Select an item using the cursor buttons ▲/▼ on the projector or remote control, and press the cursor button ► on the projector or remote control, or the ENTER button on the remote control to progress. Then perform it referring to the following table.

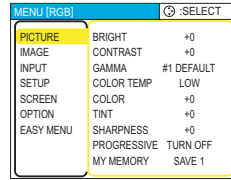

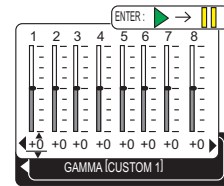

ENGLISH

Item	Description
<b>BRIGHT</b>	Using the buttons ▲/▼ adjusts the brightness. : Light ⇔ Dark
<b>CONTRAST</b>	Using the buttons ▲/▼ adjusts the contrast. : Strong ⇔ Weak
<b>GAMMA</b>	<p>Using the buttons ▲/▼ switches the GAMMA mode. :</p> <p>#1 DEFAULT ⇔ #1 CUSTOM ⇔ #2 DEFAULT</p> <p>⇕</p> <p>#3 CUSTOM ⇔ #3 DEFAULT ⇔ #2 CUSTOM</p> <p><b>To adjust #1 CUSTOM, #2 CUSTOM or #3 CUSTOM</b></p> <p>Selecting a mode of CUSTOM and then pressing the button ► or the ENTER button displays a dialog to aid you in adjusting the mode.</p> <p>This function is useful when you want to change the brightness of particular tones.</p> <p>Choose an item using the buttons ◀/▶, and adjust the level using the buttons ▲/▼.</p> <p>You can display a test pattern for checking the effect of your adjustment by pressing the ENTER button. Each time you press the ENTER button, the pattern changes as below.</p> <p>No pattern ⇔ Gray scale of 9 steps ⇐</p> <p>⇑ Ramp ⇔ Gray scale of 15 steps</p> <p>Eight of equalizing bars corresponds to eight of tone level of test pattern except the darkest in the left end. If you want to adjust the 2nd tone from left end on the test pattern, use the equalizing adjustment bar "1". The darkest tone at the left end of the test pattern cannot be controlled with any of equalizing adjustment bar.</p>

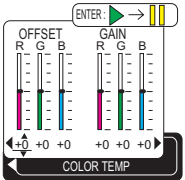

**PICTURE Menu (continued)**

Item	Description
<p><b>COLOR TEMP</b></p>	<p>Using the buttons ▲/▼ switches the mode of color temperature.  HIGH ⇔ MIDDLE ⇔ LOW ⇔ CUSTOM  </p> <p><b>To adjust CUSTOM</b></p> <p>Selecting the CUSTOM and then pressing the button ► or the ENTER button displays a dialog to aid you in adjusting the OFFSET and/or GAIN of CUSTOM mode.</p> <p>OFFSET adjustments change the color intensity on the whole tones of the test pattern.</p> <p>GAIN adjustments mainly affect color intensity on the brighter tones of the test pattern.</p> <p>Choose an item using the buttons ◀/▶, and adjust the level using the buttons ▲/▼.</p> <p>You can display a test pattern for checking the effect of your adjustment by pressing the ENTER button. Each time you press the ENTER button, the pattern changes as below.</p> <p>No pattern ⇔ Gray scale of 9 steps    Ramp ⇔ Gray scale of 15 steps</p> 
<p><b>COLOR</b></p>	<p>Using the buttons ▲/▼ adjusts the strength of whole color.  Strong ⇔ Weak</p> <ul style="list-style-type: none"> <li>• This item can be selected only at a video signal.</li> </ul>
<p><b>TINT</b></p>	<p>Using the buttons ▲/▼ adjusts the tint.  Green ⇔ Red</p> <ul style="list-style-type: none"> <li>• This item can be selected only at a video signal except for SECAM.</li> </ul>
<p><b>SHARPNESS</b></p>	<p>Using the buttons ▲/▼ adjusts the sharpness.  Strong ⇔ Weak</p>

**PICTURE Menu (continued)**

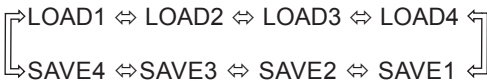
Item	Description
<p><b>PROGRESSIVE</b></p>	<p>Using the buttons ▲/▼ switches the progressive mode.            TV ⇔ FILM ⇔ TURN OFF  </p> <ul style="list-style-type: none"> <li>• This function performs only at an interlaced signal of a VIDEO input, a S-VIDEO input or a COMPONENT VIDEO input of 525i (480i) or 625i (576i) signal.</li> <li>• When the TV or FILM is selected, the screen image will be crisper. The FILM mode is adaptable to the 2-3 Pull-Down system to the conversion. But these may cause a certain defect (for example, jagged line) of the picture at a quick moving object. In such a case, please select the TURN OFF, even though the screen image may lose the crisp.</li> </ul>
<p><b>MY MEMORY</b></p>	<p>Selecting a mode of MY MEMORY using the buttons ▲/▼ and then pressing the button ► or the ENTER button performs each function.</p> <p></p> <p>This projector has 4 numbered memories for adjustment data. Performing the LOAD1, LOAD2, LOAD3 or LOAD4 loads the data on the memory whose number corresponds with the command's number, and adjusts the picture automatically depending on the data. Performing the SAVE1, SAVE2, SAVE3 or SAVE4 puts the current adjustment data on the memory whose number corresponds with the command's number.</p>

## IMAGE Menu

With the IMAGE menu, items shown in the table below can be performed.

Select an item using the cursor buttons ▲/▼ on the projector or remote control, and press the cursor button ► on the projector or remote control, or the ENTER button on the remote control to progress. Then perform it referring to the following table.

MENU [RGB]		◀ SELECT
PICTURE	ASPECT	43
IMAGE	OVER SCAN	95
INPUT	V POSITION	25
SETUP	H POSITION	142
SCREEN	H PHASE	16
OPTION	H SIZE	1344
EASY MENU	AUTO ADJUST	

Item	Description
<b>ASPECT</b>	<p>Using the buttons ▲/▼ switches the mode for aspect ratio.</p> <p><b>At a RGB signal</b> 4:3 ⇄ 16:9 ⇄ NORMAL ↑—————↑</p> <p><b>At a video signal / no signal</b> 4:3 ⇄ 16:9 ⇄ SMALL ↑—————↑</p> <ul style="list-style-type: none"> <li>• The NORMAL mode keeps the original aspect ratio of the signal.</li> <li>• At a HDTV signal of 1125i (1080i) or 750p (720p) of COMPONENT VIDEO input, this item can't be selected.</li> <li>• Performing the automatic adjustment initializes the aspect ratio setting.</li> </ul>
<b>OVER SCAN</b>	<p>Using the buttons ▲/▼ adjusts the over-scan ratio. Large (It reduces picture) ⇄ Small (It magnifies picture)</p> <ul style="list-style-type: none"> <li>• This item can be selected only at a video signal.</li> <li>• When this adjustment is too large, certain degradation may appear at the frame area of the picture. In such a case, please adjust small.</li> </ul>
<b>V POSITION</b>	<p>Using the buttons ▲/▼ adjusts the vertical position. Up ⇄ Down</p>
<b>H POSITION</b>	<p>Using the buttons ▲/▼ adjusts the horizontal position. Left ⇄ Right</p>
<b>H PHASE</b>	<p>Using the buttons ▲/▼ adjusts the horizontal phase to eliminate flicker. Right ⇄ Left</p> <ul style="list-style-type: none"> <li>• This item can be selected only at a RGB signal or a component video signal.</li> </ul>

**IMAGE Menu (continued)**

Item	Description
<b>H SIZE</b>	<p>Using the buttons ▲/▼ adjusts the horizontal size. Large ↔ Small</p> <ul style="list-style-type: none"> <li>• This item can be selected only at a RGB signal.</li> <li>• When this adjustment is excessive, the picture may not be displayed correctly. In such a case, please reset the adjustment pressing the RESET button on the remote control during this operation.</li> </ul>
<b>AUTO ADJUST</b>	<p>Selecting this item performs the automatic adjustment feature.</p> <p><b>At a RGB signal</b> The vertical position, the horizontal position, the clock phase and horizontal size will be automatically adjusted. Make sure that the application window is set to its maximum size prior to attempting to use this feature. A dark picture may still be incorrectly adjusted. Use a bright picture when adjusting.</p> <p><b>At a video signal</b> The video format best suited for the respective input signal will be selected automatically. This function is available only when the AUTO mode is selected to the item VIDEO FORMAT of INPUT menu. For a component video signal, the signal type is identified automatically independently of this function.</p> <ul style="list-style-type: none"> <li>• The automatic adjustment operation requires approximately 10 seconds. Also please note that it may not function correctly with some input.</li> </ul>



**INPUT Menu (continued)**

Item	Description
<p><b>INFORMATION</b></p>	<p>Selecting this item displays a dialog titled “INPUT INFORMATION”. It shows the information about the current input.</p> <div style="display: flex; justify-content: space-around; align-items: flex-start;"> <div style="border: 1px solid black; padding: 5px; width: 30%; text-align: center;"> <p>◀ INPUT-INFORMATION</p> <p>RGB</p> <p>1024x768 @60.0</p> <p>FRAME LOCK</p> </div> <div style="border: 1px solid black; padding: 5px; width: 30%; text-align: center;"> <p>◀ INPUT-INFORMATION</p> <p>S-VIDEO</p> <p>SECAM</p> <p>AUTO</p> </div> <div style="border: 1px solid black; padding: 5px; width: 30%; text-align: center;"> <p>◀ INPUT-INFORMATION</p> <p>COMPONENT</p> <p>576i @50</p> <p>SCART RGB</p> </div> </div> <ul style="list-style-type: none"> <li>• The “FRAME LOCK” message on the dialog means the frame lock function is working (<a href="#">📖30</a>).</li> <li>• The “SCART RGB” message means the COMPONENT VIDEO port is working as a SCART RGB input port. Please refer to the item COMPONENT in this section. (<a href="#">📖30</a>)</li> <li>• This item is can't be selected at no signal.</li> </ul>





## SETUP Menu

With the SETUP menu, items shown in the table below can be performed.

Select an item using the cursor buttons ▲/▼ on the projector or remote control, and press the cursor button ► on the projector or remote control, or the ENTER button on the remote control to progress. Then perform it referring to the following table.

MENU [RGB]	◀ SELECT
PICTURE	KEystone 00
IMAGE	WHISPER NORMAL
INPUT	MIRROR NORMAL
<b>SETUP</b>	VOLUME 16
SCREEN	
OPTION	
EASY MENU	

Item	Description
<b>KEystone</b>	<p>Using the buttons ▲/▼ corrects the keystone distortion. Upper in the data ⇔ Lower in the data</p> <ul style="list-style-type: none"> <li>• The adjustable range of this function will vary with the type of input signal. At some signals, this function may not work well.</li> <li>• When the V:INVERT or the H&amp;V:INVERT is selected under the item MIRROR, if the projector screen is inclined or if the projector is angled downward, this function may not work correctly.</li> <li>• When the zoom adjustment is set to the TELE side, this correction may be excessive. This function should be used with zoom set to WIDE whenever possible.</li> </ul>
<b>WHISPER</b>	<p>Using the buttons ▲/▼ turns off/on the whisper mode. NORMAL ⇔ WHISPER</p> <ul style="list-style-type: none"> <li>• When the WHISPER is selected, acoustic noise and screen brightness are reduced.</li> </ul>
<b>MIRROR</b>	<p>Using the buttons ▲/▼ switches the mode for mirror status.</p>  <p>NORMAL ⇔ H:INVERT ⇔ V:INVERT ⇔ H&amp;V:INVERT</p> 
<b>VOLUME</b>	<p>Using the buttons ▲/▼ adjusts the volume. High ⇔ Low</p>

SCREEN Menu

With the SCREEN menu, items shown in the table below can be performed.

Select an item using the cursor buttons ▲/▼ on the projector or remote control, and press the cursor button ► on the projector or remote control, or the ENTER button on the remote control to progress. Then perform it referring to the following table.

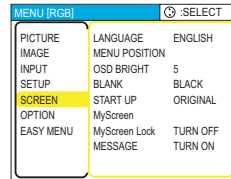

ENGLISH

Item	Description
<b>LANGUAGE</b>	<p>Using the buttons ▲/▼ switches the OSD (On Screen Display) language.</p> <p>→ ENGLISH ⇄ FRANÇAIS ⇄ DEUTSCH ⇄ ESPAÑOL ⇄ ITALIANO                      ↓                      NORSK ⇄ NEDERLANDS ⇄ PORTUGUÊS ⇄ 日本語 ⇄ 中文                      ↓                      한글 ⇄ SVENSKA ⇄ РУССКИЙ ⇄ SUOMI ⇄ POLSKI</p>
<b>MENU POSITION</b>	<p>Using the buttons ◀/▶/▲/▼ adjusts the menu position. To quit the operation, press the MENU button on the remote control or keep no operation for 10 seconds.</p>
<b>OSD BRIGHT</b>	<p>Using the buttons ▲/▼ switches the brightness level of the OSD (On Screen Display).                      Bright ⇄ Dark</p>
<b>BLANK</b>	<p>Using the buttons ▲/▼ switches the mode for the blank screen. The blank screen is the screen for the temporarily blanking feature (📄20). It is displayed by pressing the BLANK button on the remote control.</p> <p>MyScreen ⇄ ORIGINAL ⇄ BLUE ⇄ WHITE ⇄ BLACK                      ↑</p> <p>MyScreen is the screen you can register a desired screen. ORIGINAL screen is the existing standard screen. BLUE, WHITE and BLACK are non-patterned (plain) screens in each color.</p> <ul style="list-style-type: none"> <li>• To avoid remaining as an afterimage, the MyScreen and the ORIGINAL screens will change to the BLACK screen after several minutes.</li> <li>• For the MyScreen, please refer to the item MyScreen (📖34).</li> </ul>

**SCREEN Menu (continued)**

Item	Description
<p><b>START UP</b></p>	<p>Using the buttons ▲/▼ switches the mode for the start up screen. The start up screen is the screen displayed when no signal or an unsuitable signal is detected.</p> <p style="text-align: center;">MyScreen ⇔ ORIGINAL ⇔ TURN OFF</p>  <p>MyScreen is the screen you can register a desired screen. ORIGINAL screen is the existing standard screen. When the TURN OFF is selected, the BLUE screen is used.</p> <ul style="list-style-type: none"> <li>• To avoid remaining as an afterimage, the MyScreen and the ORIGINAL screens will change to the BLANK screen after several minutes. If also the BLANK screen is the MyScreen or ORIGINAL, it will change to the BLACK screen.</li> <li>• For the MyScreen, please refer to the item MyScreen below. About the BLUE, BLACK and BLANK screens, please refer to the item BLANK (p.33).</li> </ul>
<p><b>My Screen</b></p>	<p>This item functions for capturing the MyScreen of the blank screen and the start up screen. Please execute displaying the input including the picture you want to capture.</p> <ol style="list-style-type: none"> <li>1. Selecting this item displays a dialog titled “MyScreen”. It will ask you if you start capturing the picture from the current screen. Please wait for the target picture to be displayed, and press the ENTER button on the remote control when the picture is display. The picture will freeze and the frame for capturing appears. To stop performing, press the RESET or ESC button on the remote control.</li> <li>2. Using the buttons ◀/▶/▲/▼ adjust the frame position. Please move the frame to the position of the picture which you want to use. To start registration, press the ENTER button on the remote control. To restore the screen and return to the previous dialog, press the RESET or ESC button on the remote control.</li> </ol> <p>Registration takes several minutes. When the registration is completed, the registered screen and the message “MyScreen registration is finished.” are displayed for several seconds. If the registration failed, the message “A capturing error has occurred. Please try again.” is displayed.</p>
<p><b>My Screen Lock</b></p>	<p>Using the buttons ▲/▼ turns on/off the MyScreen lock function.</p> <p style="text-align: center;">TURN ON ⇔ TURN OFF</p> <p>When the TURN ON is selected, the item MyScreen cannot be performed. Use this function for protecting the current MyScreen.</p>

**SCREEN Menu (continued)**

Item	Description
<p><b>MESSAGE</b></p>	<p>Using the buttons ▲/▼ turns on/off the message function.                      TURN ON ⇔ TURN OFF</p> <p>When the TURN ON is selected, the following message function works.</p> <p>“AUTO IN PROGRESS” while automatically adjusting                      “NO INPUT IS DETECTED”                      “SYNC IS OUT OF RANGE”                      “Searching ....” while searching for an input signal                      “Detecting...” when an input signal is detected                      The indication of the input signal by changing                      The indication of the aspect ration by changing .</p>

ENGLISH









**OPTION Menu (continued)**

Item	Description
<p><b>FILTER TIME</b></p>	<p>The filter time is the time counted after the last resetting. It is shown in the OPTION menu as the use time of the air filter. Pressing the RESET button on the remote control for about 3 seconds displays a dialog. To reset the filter time, select the RESET using the button ▲.</p> <p>RESET ⇄ CANCEL</p> <ul style="list-style-type: none"> <li>• Please reset the filter time only when you have cleaned or replaced the air filter, for correct messages about the air filter.</li> <li>• About the caring the air filter, please see the section "Air filter" (40).</li> </ul>
<p><b>SERVICE</b></p>	<p>Selecting this item displays the SERVICE menu. Select an item using the buttons ▲/▼, and press the button ► or the ENTER button on the remote control to progress.</p> <p>FAN SPEED ⇄ GHOST ⇄ FACTORY RESET</p> <p style="text-align: center;">↑—————↑</p> <p><b>FAN SPEED</b> Using the buttons ▲/▼ switches the rotation speed of the cooling fans. The HIGH is the mode for use at highlands etc. Note that the projector is noisier when the HIGH is selected.</p> <p>HIGH ⇄ NORMAL</p> <p><b>GHOST</b></p> <ol style="list-style-type: none"> <li>1. Select a color element of ghost using the buttons ▲/▼ and press the cursor button ► or the ENTER button on the remote control to progress.</li> <li>2. Adjust the selected element using the buttons ▲/▼ to disappear ghost.</li> </ol> <p><b>FACTORY RESET</b> Selecting RESET using the button ▲ performs this function. By this function, all the items in all of menu will collectively return to the initial setting. Note that the items LAMP TIME, FILTER TIME and LANGUAGE are not reset.</p> <p>RESET ⇄ CANCEL</p>

## Maintenance

## Lamp

 <b>WARNING</b>  HIGH VOLTAGE  HIGH TEMPERATURE  HIGH PRESSURE	
<p>► The projector uses a high-pressure mercury glass lamp. The lamp can <u>break with a loud bang, or burn out</u>, if jolted or scratched, handled while hot, or worn over time. Note that each lamp has a different lifetime, and some may burst or burn out soon after you start using them. In addition, when the bulb bursts, it is possible for <u>shards of glass</u> to fly into the lamp housing, and for <u>gas containing mercury</u> to escape from the projector's vent holes.</p>	
<p>► <b>About disposal of a lamp</b> • This product contains a mercury lamp; do not put in trash. Dispose of in accord with environmental laws. For lamp recycling, go to <a href="http://www.lamprecycle.org">www.lamprecycle.org</a>. (in the US) For product disposal, contact your local government agency or <a href="http://www.eiae.org">www.eiae.org</a> (in the US) or <a href="http://www.epsc.ca">www.epsc.ca</a> (in Canada). For more information, call your dealer.</p>	
 <p>Disconnect the plug from the power outlet</p>	<ul style="list-style-type: none"> <li>• If the lamp should break (it will make a loud bang when it does), unplug the power cord from the outlet, and make sure to request a replacement lamp from your local dealer. Note that shards of glass could damage the projector's internals, or cause injury during handling, so please do not try to clean the projector or replace the lamp yourself.</li> <li>• If the lamp should break (it will make a loud bang when it does), ventilate the room well, and make sure not to breathe the gas that comes out of the projector vents, or get it in your eyes or mouth.</li> <li>• Before replacing the lamp, turn the projector off and unplug the power cord, then wait at least 45 minutes for the lamp to cool sufficiently. Handling the lamp while hot can cause burns, as well as damaging the lamp.</li> </ul>
	<ul style="list-style-type: none"> <li>• Never unscrew except the appointed (marked by an arrow) screws.</li> <li>• Do not open the lamp cover while the projector is suspended from above. This is dangerous, since if the lamp's bulb has broken, the shards will fall out when the cover is opened. In addition, working in high places is dangerous, so ask your local dealer to have the lamp replaced even if the bulb is not broken.</li> <li>• Do not use the projector with the lamp cover removed. At the lamp replacing, make sure that the screws are screwed in firmly. Loose screws could result in damage or injury.</li> </ul>
	<ul style="list-style-type: none"> <li>• Use only the lamp of the specified type.</li> <li>• If the lamp breaks soon after the first time it is used, it is possible that there are electrical problems elsewhere besides the lamp. If this happens, contact your local dealer or a service representative.</li> <li>• Handle with care: jolting or scratching could cause the lamp bulb to burst during use.</li> <li>• If the indicators or a message prompts you to replace the lamp (see the section "Related Messages" and "Regarding the indicator Lamps"), replace the lamp as soon as possible. Using the lamp for long periods of time, or past the replacement date, could cause it to burst. Do not use old (used) lamps; this is a cause of breakage.</li> </ul>

**Lamp (continued)**

When the indicators or a message prompts you to replace the lamp, replace the lamp as soon as possible.

1. Turn the projector off, and unplug the power cord. Allow the lamp to cool for at least 45 minutes.
2. To prepare a new lamp, contact your dealer and tell the lamp type number = **ZU0218044010(DT00671)**. If the projector is mounted on the ceiling, or if the lamp has broken, also ask the dealer to replace the lamp.

**In the case of replacement by yourself,**

3. After making sure that the projector has cooled adequately, slowly turn over the projector, so that the bottom is facing up.
4. Please unhook the claws of the lamp cover using a minus screwdriver or similar, and remove the lamp cover.
5. Loosen the 2 screws (marked by arrow) of the lamp, and slowly pick up the lamp by the handles.
6. Insert the new lamp, and retighten firmly two screws that are loosened in the previous process to lock it in place.
7. Interlocking the 2 tabs of the lamp cover to the projector, position the lamp cover on the projector. Then push the center point of two claws to fix the lamp cover.
8. Slowly turn the projector so that the top is facing up.
9. Turn the projector on, and reset the lamp time using the LAMP TIME function of OPTION menu (36).

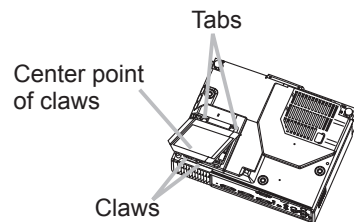
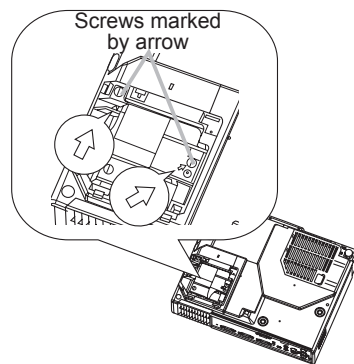
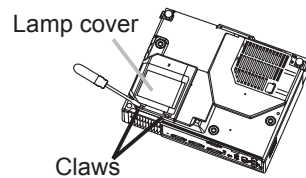

**NOTE** • When the lamp has been replaced after the message of "THE POWER WILL TURN OFF AFTER 0hr." is displayed, complete the following operation within 10 minutes of switching power on.

- Incorrectly resetting of the lamp timer (resetting without replacement, or neglect of resetting after replacement) will result in incorrect message functions.



## Air filter

**⚠ WARNING** ▶ Before caring, make sure the power switch is off and the power cable is not plugged in, then allow the projector to cool sufficiently. The care in a high temperature state of the projector could cause a burn and/or malfunction to the projector.

▶ Use only the air filter of the specified type. Do not use the projector with the air filter and filter cover removed.

▶ Avoid wetting the projector or inserting liquids in the projector. It could result in a fire, an electric shock, and and/or malfunction to the projector.

**⚠ CAUTION** ▶ Please replace the air filter when it is damaged or too soiled, and also when you replace the lamp.

When the indicators or a message prompts you to clean the air filter, clean the air filter as soon as possible. If the air filter becomes clogged by dust or the like, internal temperatures rise and the power may be automatically turned off for malfunction prevention.

1. Turn the projector off, and unplug the power cord.  
Allow the projector to cool for at least 45 minutes. And prepare a vacuum cleaner.
2. After making sure that the projector is cool adequately, slowly turn the projector so that the lens-side is facing up. Please be careful for a projector not to fall. While the projector is placed lens-side up, hold the projector.
3. Putting a finger on the filter cover's knob, slide the filter cover in the direction of the arrow to remove it.
4. Holding the air filter's knob, pull the air filter off.
5. Apply a vacuum cleaner to the vent of the projector for the air filter. And then slowly turn the projector bottom up.
6. Apply a vacuum cleaner to the air filter and filter cover.  
Please replace the air filter when it is damaged or too soiled.

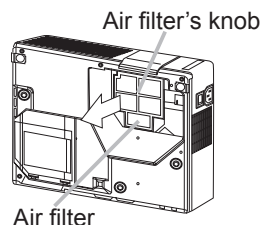
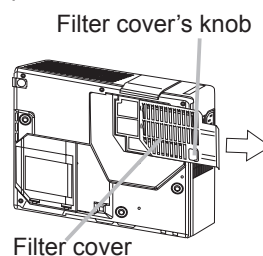

To prepare a new air filter, contact your dealer and tell the air filter type number = **EK0218011150(NJ09702)**.

An air filter of specified type will come even with the replacement lamp for this projector.

7. Position the cleaned air filter or a new air filter into place, and push the points of "PUSH" word with claws to fix the air filter.
8. Replace the filter cover and snap it back into place.
9. Slowly turn the projector so that the top is facing up.
10. Turn the projector on, and reset the filter time using the FILTER TIME function of OPTION menu (📖37).

**NOTE** • Incorrectly resetting of the filter timer (resetting without replacement, or neglect of resetting after replacement) will result in incorrect message functions.

## Other care

**⚠ WARNING** ▶ Before caring, make sure the power switch is off and the power cable is not plugged in, and then allow the projector to cool sufficiently. The care in a high temperature state of the projector could cause a burn and/or malfunction to the projector.

▶ Never try to care for the inside of the projector personally. Doing is so dangerous.

▶ Avoid wetting the projector or inserting liquids in the projector. It could result in a fire, an electric shock, and and/or malfunction to the projector.

- Don't put a container containing water, cleaner or chemicals near the projector.

- Don't use aerosols or sprays.

**⚠ CAUTION** ▶ Please take right care of the projector according to the following. Incorrect care could cause not only an injury but adverse influence such as discoloration, peeling paint, etc.

- Do not use cleaner or chemicals other than those listed below.

- Do not polish or wipe with hard objects.

### Inside of the projector

In order to ensure the safe use of your projector, please have it cleaned and inspected by your dealer about once every 2 years.

### Caring for the lens

If the lens is flawed, soiled or fogged, it could cause deterioration of display quality. Please take care of the lens, being cautious of the handling.

1. Turn the projector off, and unplug the power cord. Allow the projector to cool sufficiently.
2. After making sure that the projector is cool adequately, lightly wipe the lens with a commercially available lens-cleaning wipe. Do not touch the lens directly with your hand.

### Caring for the cabinet and remote control

Incorrect care could have adverse influence such as discoloration, peeling paint, etc.

1. Turn the projector off, and unplug the power cord. Allow the projector to cool sufficiently.
2. After making sure that the projector is cool adequately, lightly wipe with gauze or a soft cloth.

If soiling is severe, dip soft cloth in water or a neutral cleaner dilute in water, and wipe lightly after wringing well. Then, wipe lightly with a soft, dry cloth.

## Troubleshooting

### Related messages

When the unit's power is on, messages such as those shown below may be displayed. When any such message is displayed on the screen, please respond as described below. If the same message is displayed after the treatment, or if a message other than the following appears, please contact your dealer or service company.

Although these messages will be automatically disappeared around several minutes, it will be reappeared every time the power is turned on.

Message	Description
<p>☼ <b>CHANGE THE LAMP</b></p> <p><b>AFTER REPLACING LAMP, RESET THE LAMP TIMER.</b></p>	<p><b>The time the lamp timer has counted is approaching 2000 hours.</b></p> <p>Preparation of a new lamp, and an early lamp change is recommended. After you have change the lamp, please be sure to reset the lamp timer (☞36).</p>
<p>☼ <b>CHANGE THE LAMP</b></p> <p><b>AFTER REPLACING LAMP, RESET THE LAMP TIMER.</b></p> <p><b>THE POWER WILL TURN OFF AFTER ** hr.</b></p>	<p><b>The time the lamp timer has counted is approaching 2000 hours, so a lamp change within ** hours is recommended.</b></p> <p>When lamp usage reaches 2000 hours, the power will automatically be turned off. Please change the lamp by referring to the section “Lamp”. After you have changed the lamp, please be sure to reset the lamp timer (☞36).</p>
<p>☼ <b>CHANGE THE LAMP</b></p> <p><b>AFTER REPLACING LAMP, RESET THE LAMP TIMER.</b></p> <p><b>THE POWER WILL TURN OFF AFTER 0 hr.</b></p>	<p><b>As the time the lamp timer has counted has reached 2000 hours, the power will soon be automatically turned off.</b></p> <p>Please immediately turn the power off, and change the lamp by referring to the section “Lamp”. After changing the lamp, please be sure to reset the lamp timer (☞36).</p>
<p><b>NO INPUT IS DETECTED</b> ON ***</p>	<p><b>There is no input signal.</b></p> <p>Please confirm the signal input connection, and the status of the signal source.</p>
<p><b>SYNC IS OUT OF RANGE</b> ON *** [fH] *****kHz [fV] *****Hz</p>	<p><b>The horizontal or vertical wavelength of the inputted signal is outside of the response parameters of this unit.</b></p> <p>Please confirm the specs for this unit or the signal source specs.</p>
<p><b>CHECK THE AIR FLOW</b></p>	<p><b>The internal portion temperature is rising.</b></p> <p>Please turn the power OFF, and allow the unit to cool down at least 20 minutes. After having confirmed the following items, please turn the power ON again.</p> <ul style="list-style-type: none"> <li>• Is there blockage of the air passage aperture?</li> <li>• Is the air filter dirty?</li> <li>• Does the peripheral temperature exceed 35°C?</li> <li>• If the same indication is displayed after the treatment, please set the HIGH at the FAN SPEED of the item SERVICE of the OPTION menu.</li> </ul>

**Related messages (continued)**

Message	Description
<b>CLEAN THE AIR FILTER POWER OFF FIRST, THEN CLEAN THE AIR FILTER. AFTER CLEANING THE AIR FILTER, RESET THE FILTER TIMER.</b>	<b>A note of precaution when cleaning the air filter.</b> Please immediately turn the power OFF, and clean or change the air filter by referring to the “Air Filter” section of this manual. After you have cleaned or changed the air filter, please be sure to reset the filter timer (  37).

ENGLISH

**NOTE** • A lamp has a finite product life. Lamps are characterized by the fact that, after long hours of usage, a lamp will no longer light up, or the lamp will break or burst, etc. This projector is equipped with an automatic shut-down function, such that the power will automatically be turned off when lamp usage time has reached 2000 hours. Please be aware, however, that among lamp types, there are major differences in product lifetimes; a lamp may thus fail to light even prior to the functioning of the automatic shut-down function of this projector.

## Regarding the indicator lamps

Lighting and flashing of the POWER indicator, the LAMP indicator, and the TEMP indicator have the meanings as described in the table below. Please respond in accordance with the instructions within the table. If the same indication is displayed after the treatment, or if an indication other than the following is displayed, please contact your dealer or service company.

POWER indicator	LAMP indicator	TEMP indicator	Description
Lighting In <b>Orange</b>	Turned <b>off</b>	Turned <b>off</b>	<b>The projector is in a standby state.</b> Please refer to the section "Power On/Off".
<i>Blinking</i> In <b>Green</b>	Turned <b>off</b>	Turned <b>off</b>	<b>The projector is warming up.</b> Please wait.
Lighting In <b>Green</b>	Turned <b>off</b>	Turned <b>off</b>	<b>The projector is in an on state.</b> Ordinary operations may be performed.
<i>Blinking</i> In <b>Orange</b>	Turned <b>off</b>	Turned <b>off</b>	<b>The projector is cooling down.</b> Please wait.
<i>Blinking</i> In <b>Red</b>	(discre- tionary)	(discre- tionary)	<b>The projector is cooling down. A certain error has been detected.</b> Please wait until the POWER indicator finishes blink, and then perform the proper response measure using the item descriptions below as reference.
<i>Blinking</i> In <b>Red</b> or Lighting In <b>Red</b>	Lighting In <b>Red</b>	Turned <b>off</b>	<b>The lamp does not light, and there is a possibility that interior portion has become heated.</b> Please turn the power off, and allow the unit to cool down at least 20 minutes. After the projector has sufficiently cooled down, please make confirmation of the following items, and then turn the power on again. • Is there blockage of the air passage aperture? • Is the air filter dirty? • Does the peripheral temperature exceed 35°C? If the same indication is displayed after the treatment, please change the lamp by referring to the section "Lamp".
<i>Blinking</i> In <b>Red</b> or Lighting In <b>Red</b>	<i>Blinking</i> In <b>Red</b>	Turned <b>off</b>	<b>The lamp cover has not been properly fixed (attached).</b> Please turn the power off, and allow the unit to cool down at least 45 minutes. After the projector has sufficiently cooled down, please make confirmation of the attachment state of the lamp cover. After performing any needed maintenance, turn the power on again. If the same indication is displayed after the treatment, please contact your dealer or service company.

**Regarding the indicator lamps (continued)**

POWER indicator	LAMP indicator	TEMP indicator	Description
<i>Blinking In Red</i> or Lighting In Red	Turned off	<i>Blinking In Red</i>	<b>The cooling fan is not operating.</b> Please turn the power off, and allow the unit to cool down at least 20 minutes. After the projector has sufficiently cooled down, please make confirmation that no foreign matter has become caught in the fan, etc., and then turn the power on again. If the same indication is displayed after the treatment, please contact your dealer or service company.
<i>Blinking In Red</i> or Lighting In Red	Turned off	Lighting In Red	<b>There is a possibility that the interior portion has become heated.</b> Please turn the power off, and allow the unit to cool down at least 20 minutes. After the projector has sufficiently cooled down, please make confirmation of the following items, and then turn the power on again. <ul style="list-style-type: none"> <li>• Is there blockage of the air passage aperture?</li> <li>• Is the air filter dirty?</li> <li>• Does the peripheral temperature exceed 35°C?</li> </ul> If the same indication is displayed after the treatment, please set the HIGH at the FAN SPEED of the item SERVICE of the OPTION menu.
Lighting In Green	Alternative <i>blinking in Red</i>		<b>There is a possibility that the interior portion has become overcooled.</b> Please use the unit within the usage temperature parameters (5°C to 35°C). After the treatment, resent the power to ON.
Lighting In Green	Simultaneous <i>blinking in Red</i>		<b>It is time to clean the air filter.</b> Please immediately turn the power OFF, and clean or change the air filter by referring to the section "Air Filter". After cleaning or changed the air filter, please be sure to reset the filter timer. After the treatment, resent the power to ON.

**NOTE** • When the interior portion has become overheated, for safety purposes, the power source is automatically turned off, and the indicator lamps may also be turned off. In such a case, press the "O" (OFF) side of the power switch, and wait at least 45 minutes. After the projector has sufficiently cooled down, please make confirmation of the attachment state of the lamp and lamp cover, and then turn the power on again.

## Phenomena that may easily be mistaken for machine defects

**⚠ WARNING** ▶ Never use the projector if abnormal operations such as smoke, strange odor, excessive sound, damaged casing or elements or cables, penetration of liquids or foreign matter, etc. should occur. In such cases, immediately turn off the power switch and then disconnect the power plug from the power outlet. After making sure that the smoke or odor has stopped, contact your dealer or service company.

1. Before requesting repair, please check in accordance with the following chart.  
This operation sometimes resolves your problem.

If the situation cannot be corrected,

2. The projector's microprocessor may need to be reset. Please push the Restart switch by using a cocktail stick or similar and the projector will restart.
3. Some setting may be wrong. Please use the **FACTORY RESET** function of **SERVICE** menu in the **OPTION** menu (p.37) to reset all settings to factory default.

Then, if the problem is not removed after maintenance, please contact your dealer or service company.

Phenomenon	Cases not involving a machine defect	Reference page
Power does not come on.	<b>The electrical power cord is not plugged in.</b> Correctly connect the power cord.	13
	<b>The power switch is not set to the on position.</b> Set the power switch to [   ] (On).	16
	<b>The main power source has been interrupted during operation such as by a power outage (blackout), etc.</b> Please turn the power off, and allow the unit to cool down at least 20 minutes. After the projector has sufficiently cooled down, please turn the power on again.	16
	<b>Either there is no lamp and/or lamp cover, or either of these has not been properly fixed.</b> Please turn the power off, and allow the unit to cool down at least 45 minutes. After the projector has sufficiently cooled down, please make confirmation of the attachment state of the lamp and lamp cover, and then turn the power on again.	38, 39

**Phenomena that may easily be mistaken for machine defects (continued)**

Phenomenon	Cases not involving a machine defect	Reference page
No pictures are displayed.	<b>The lens cover is closed.</b> Remove the lens cover.	4, 16
	<b>The signal cables are not correctly connected.</b> Correctly connect the connection cables.	10
	<b>The brightness is adjusted to an extremely low level.</b> Adjust the BRIGHT to a higher level using the menu function or the remote control.	23, 25
	<b>The computer cannot detect the projector as a plug and play monitor.</b> Make sure that the computer's can detect a plug and play monitor using other plug and play monitor.	10
Colors have a faded- out appearance, or Color tone is poor.	<b>Color settings are not correctly adjusted.</b> Perform picture adjustments by changing the COLOR TEMP, COLOR, TINT and/or COLOR SPACE settings, using the menu functions.	23, 25, 30
	<b>COLOR SPACE setting is not suitable.</b> Change the COLOR SPACE setting to AUTO, RGB, SMPTE240 , REC709 or REC601.	30
Pictures appear dark.	<b>The brightness and/or contrast are adjusted to an extremely low level.</b> Adjust the BRIGHT and/or CONTRAST settings to a higher level using the menu function.	24, 25
	<b>The WHISPER function is working.</b> Select the NORMAL to the item WHISPER in the SETUP menu.	24, 32
	<b>The lamp is approaching the end of its product lifetime.</b> Replace the lamp.	38, 39
Pictures appear blurry.	<b>Either the focus and/or horizontal phase settings are not properly.</b> Adjust the focus using the focus ring, and/or H PHASE using the menu function.	18, 28
	<b>The lens is dirty or misty.</b> Clean the lens by referring to the section "Caring for the lens".	41

**NOTE** • Although bright spots or dark spots may appear on the screen, this is a unique characteristic of liquid crystal displays, and such do not constitute or imply a machine defect.



## Warranty And After-Service

### Warranty and after-service

If a problem occurs with the equipment, first refer to the “Troubleshooting” and run through the suggested checks. If this does not resolve the problem, please contact your dealer or the service company. They will tell you what warranty condition is applied.

## Specifications

### Specifications

**NOTE** • This specifications are subject to change without notice.

Item		Specification
Product name		Liquid crystal projector
Liquid Crystal panel	Panel size	1.8 cm (0.7 type)
	Drive system	TFT active matrix
	Pixels	786,432 pixels (1024 horizontal x 768 vertical)
Lens		Zoom lens F=1.7 ~ 1.9 f=21.8 ~ 26.2 mm
Lamp		165W UHB
Power Supply		AC100-120V/2.7A, AC220-240V/1.5A
Power Consumption		240W
Temperature range		5 ~ 35°C (Operating)
Size		297 (W) x 64 (H) x 233 (D) mm (Not including protruding parts) • Please refer to the following figure.
Weight (mass)		2.5 kg
Ports		<b>RGB input:</b> RGB IN1 ..D-sub 15pin mini x1 RGB IN2 ..D-sub 15pin mini x1 <b>RGB output:</b> RGB OUT D-sub 15pin mini x1 <b>Communication port:</b> CONTROL..... D-sub 9pin x1 USB..... USB(B) x1 <b>Video input:</b> COMPONENT VIDEO Y ..... RCA x1 CB/PB..... RCA x 1 CR/PR ..... RCA x 1 S-Video ..... 1 Video ..... 1 <b>Audio input:</b> AUDIO IN1 ..... Stereo mini x1 AUDIO IN2 ..... Stereo mini x1 <b>Audio output:</b> AUDIO OUT ... Stereo mini x1
Optional parts	Lamp	ZU0218044010 (DT00671)
	Air filter	EK0218011150 (NJ09702)
	Others	• Please consult your dealer.

Specifications (continued)

ENGLISH

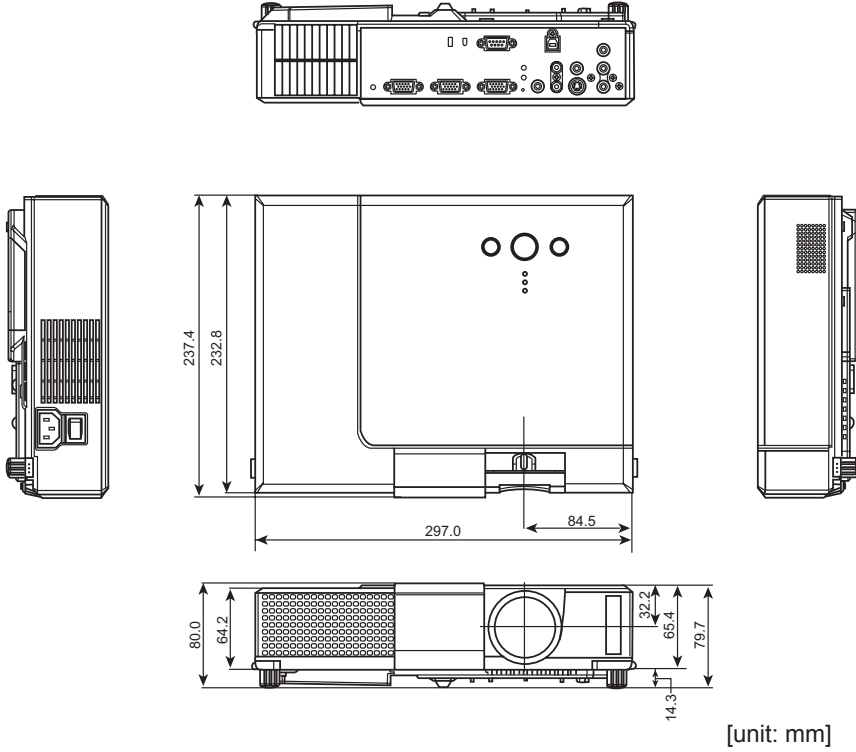

Liesegang Optoelectronics GmbH • Kaistrasse 5 • D-40221 Düsseldorf • Postfach 10 35 53 • D-40026 Düsseldorf  
Telefon (0211) 3901-1 • Telefax (0211) 39 01-227  
Internet <http://www.liesegang.de> • e-mail [info@liesegang.de](mailto:info@liesegang.de)

\*QR62311\*

Printed in China